

# HSX 150 - 24000/17

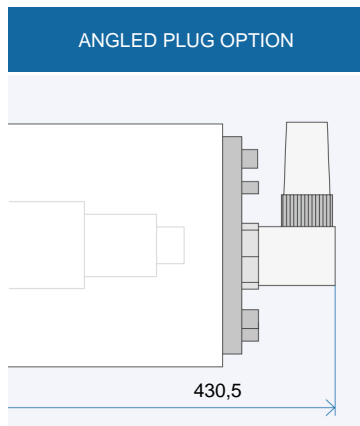

Technical data		
∅ Spindle housing	A	[mm]
Speed max.	$n_{max}$	[min <sup>-1</sup> ]
Bearing; front	$W_1$	[mm]
Tool interface		
∅ Flat layout	W	[mm]
Static rigidity		
axial	$C_{ax}$	[N/μm]
radial	$C_{rad}$	[N/μm]
Motor realization		
Frequency max.	$f_{max}$	[Hz]
Converter voltage <sup>1)</sup>		[V]
Power	$P_{S1}$	[kW]
Torque	$M_{S1}$	[Nm]
... at speed	$n$	[min <sup>-1</sup> ]
Current	$I_{S1}$	[A]
Power	$P_{S6-60\%}$	[kW]
Torque	$M_{S6-60\%}$	[Nm]
... at speed	$n$	[min <sup>-1</sup> ]
Current	$I_{S6-60\%}$	[A]

HSX 150 - 24000/17			
150			
24000			
65			
D 36/63			
63			
130			
147			
200 V	350 V	460 V	
800			
200	350	460	
14			
12,2			
11000			
65	37	28	
17			
14,8			
11000			
79	45	34	

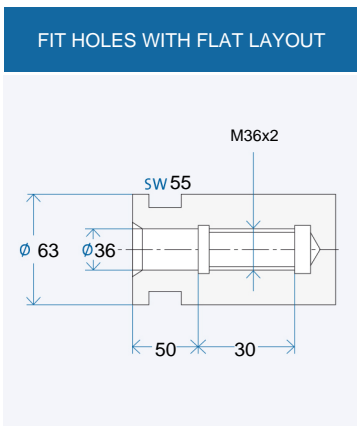
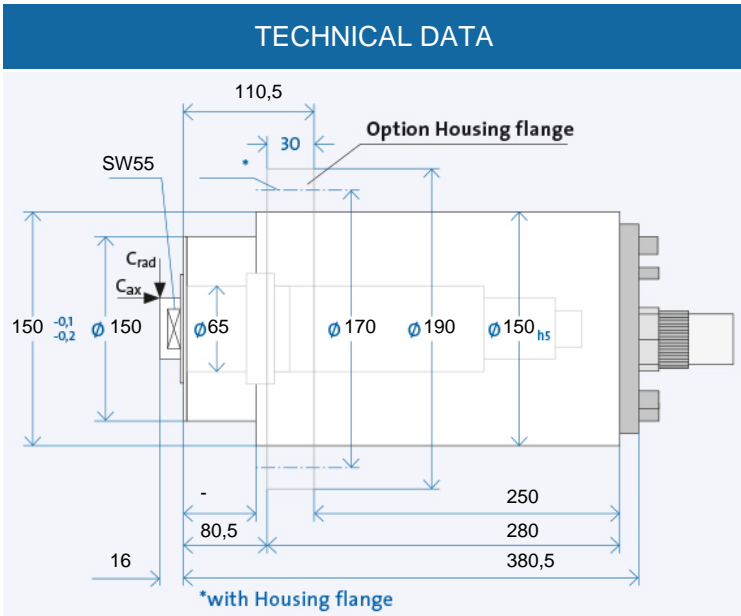

Electrical connection		
Plug type	MAC	
Straight plug connection	+	+
Coil plug connector	o	o
Fixed cable XXm	o	o
Coolant feed through the shaft		
Low pressure (du)	x	
High-pressure (dh)	x	
Sensors		
Rotary encoder	x	
Speed sensor	+	
Housing		
Cylindrical housing	+	
Cylindrical housing with flange	o	
Block housing	x	
Air-tight seal	o	

Electrical connection		
Plug type	MAC	GA
Straight plug connection	+	+
Coil plug connector	o	o
Fixed cable XXm	o	o
Coolant feed through the shaft		
Low pressure (du)	x	
High-pressure (dh)	x	
Sensors		
Rotary encoder	x	
Speed sensor	+	
Housing		
Cylindrical housing	+	
Cylindrical housing with flange	o	
Block housing	x	
Air-tight seal	o	

<sup>1)</sup> Minimum required starting voltage for the frequency converter.

- + Standard
- o Optional
- x Upon request

**Ordering information:**  
 HSX 150 - 24000/17  
 R is for clockwise, L for counter-clockwise  
 + Desired options

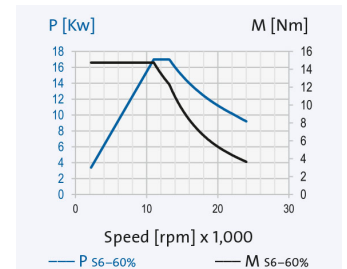

The data currently provided on the internet apply. Further and detailed information is provided in the GMN 2508 catalogue.

# HSX 150 - 24000/17

## Grinding quills

GMN produces grinding quills with high round and flat face accuracy for all available GMN grinding mandrel receivers.

FIG. 1: CEMENTED (KI)

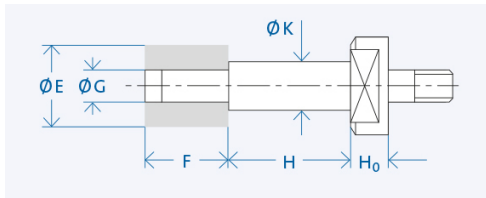

FIG. 2: WITH ADJUSTMENT SCREW (PS)

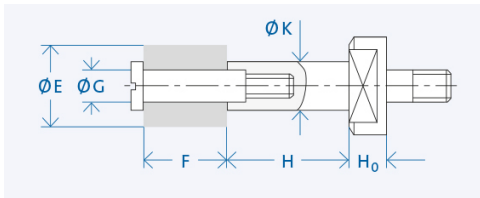
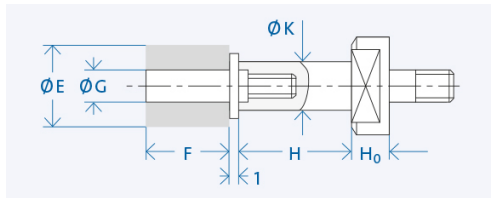
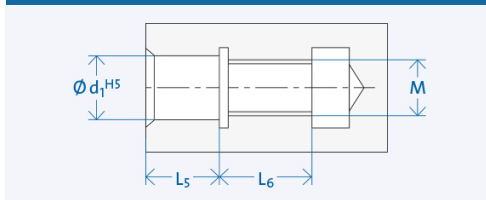

FIG. 3: FOR GRINDING WHEELS ON THREADED PIN (PL)\*



FITTING HOLE FOR FIG. 2 AND 3



d <sub>1</sub>	M	L <sub>5</sub>	L <sub>6</sub>
4	M3	5	8
6	M5	7	11
8	M6	9	12
10	M8	12	14
13	M12	13	17

Interface	K [mm]	H [mm]	Wheel E x F [mm]	G [mm]	Grinding wheel attachment	H <sub>0</sub> [mm]
D 36/63	25	50	40 x 32	16	MU	15
	32	63	50 x 40	20	MU	
	50	100	80 x 40	32	MU	

### Ordering information:

[Mandrel Ø K] x [Mandrel length H] - [Grinding wheels ø G] x [Grinding wheel width F] [Interface] [Mandrel fixation]

Example: Grinding quill 16 x 40 - 10 x 25 D16/28 PS

## Semi-finished goods

GMN semi-finished products allow the individual adaptation of the tool interface for any connections.

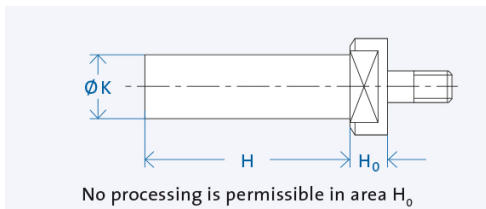

d <sub>1</sub>	K [mm]	H [mm]
D 36/63	63	150

Ordering information: »Semi-finished goods« [Shaft Ø K] x [Shaft length H] [Interface]

Example: Semi-finished goods 34 x 180 D16/33

## Lubrication system

The electronically controlled PRELUB lubrication unit is optimally adapted to the oil-air lubricated GMN spindles and guarantees a long service life.



## Cooling system

GMN cooling units ensure precisely adjustable temperature and quantity delivery of the coolant and achieve consistently low operating temperatures.



## Cable and plug

Ready-made cables with B048, B049, GA, MAC, D500 and STK plugs are available on request. For the spindle/converter connection, GMN supplies UL/CSA approved electrical cables suitable for use in drag chains.

