

TSI 60 x 250

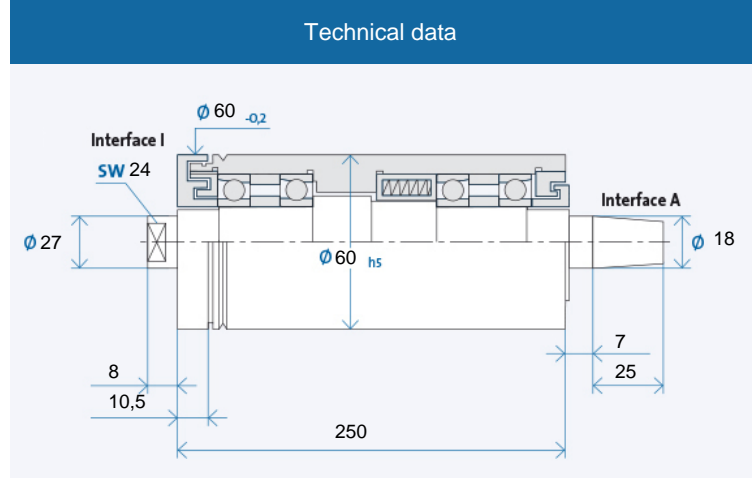

Maximum speed n_{max} [min ⁻¹]* for bearing types:	
Steel (steel)	30000
Hybrid (optional)	35000

* without tool

Ordering information: TSI 60 x 250 R is for clockwise, L for counter-clockwise

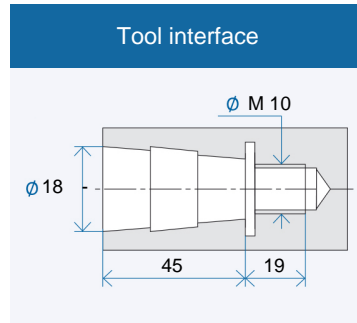
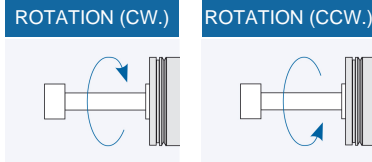

Tool interface: taper 1 : 7,5 nominal value, included angle acc. to GMN precision standards

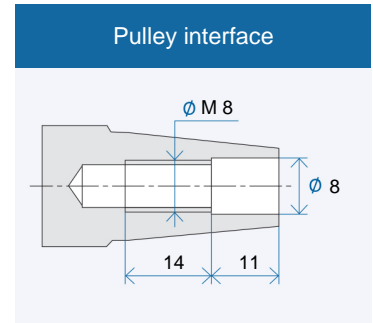

Pulley interface: taper 1 : 7,5 nominal value, included angle acc. to GMN precision standards

Accessories

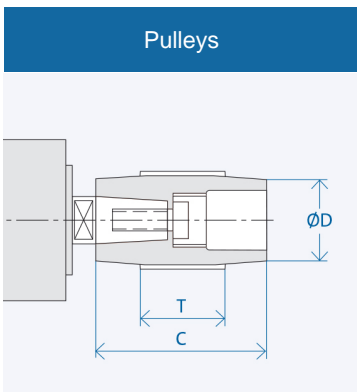

Interface	Dimensions [mm]		
	D	C	T
A 18	25	60	40
	32	60	40
	40	60	40
	100	60	40

Ordering information pulley: AX₁-X₂
 X₁: Interface: 10/13/...
 X₂: Figure from column D
 Puller for pulley: AX₁/...

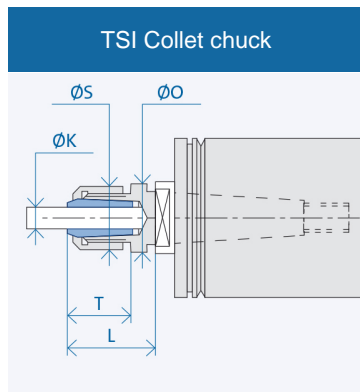

Interface	Dimensions [mm]				
	K	T	L	S	O
I 18	3	15,5	28	16	23
	4	15,5	28	16	23
	5	15,5	28	16	23
	6	15,5	28	16	23

Ordering information collet chuck: I X₁ - (K)
 X₁: Interface: 10/14/...
 (K) = Inner diameter collet chuck

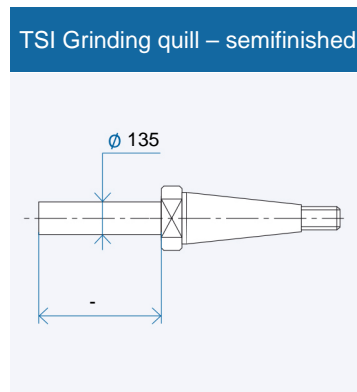

Ordering information semifinished: I X₁
 X₁: Interface 10/14/...