

Spindle ball bearings (HY)* S 61805 C

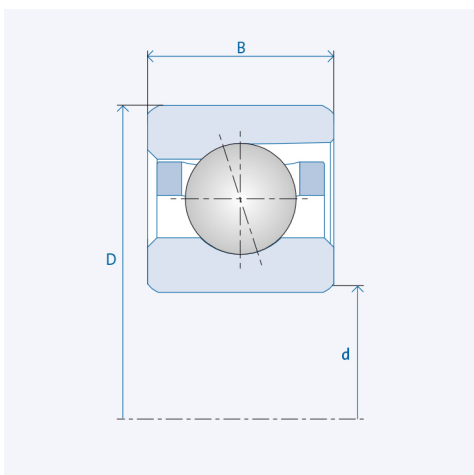

Precision class P4 / ABEC7

Components

Bearing designation:	(HY)* S 61805 C
Bearing design:	S
Series / size:	61805
Ball material:	Steel 100Cr6
Ball material HY :	Ceramic Si3N4
Cage:	TA (TXM available upon request)
Precision:	P4 (HG, UP, P2 upon request)
Main dimensions [d x D x B]:	25 x 37 x 7 mm

Technical data (Standard bearings)

Static load capacity C_0 :	2750
Dynamic load capacity C:	3650
Speed limit n_{Fett} :	41250
Speed limit n_{Oj} :	55000

Technical data (Hybrid bearings)*

Static load capacity C_{0HY} :	1930
Dynamic load capacity C_{HY} :	3650
Speed limit n_{Fett} :	51562.5
Speed limit n_{Oj} :	68750

Pre-tension

Light (L):	19 N
Axial rigidity (C_{ax}):	21 N/ μ m
Medium (M):	55 N
Axial rigidity (C_{ax}):	33 N/ μ m
Heavy (S):	110 N
Axial rigidity (C_{ax}):	46 N/ μ m
Spring preload (Ff):	95 N

The given speed limits apply to individual bearings with spring preload. Correction factors must be considered for all properties which deviate from this.

* All ball bearings are also available as hybrid ball bearings (HY).