

Spindle ball bearings (HY)* S 6002 C

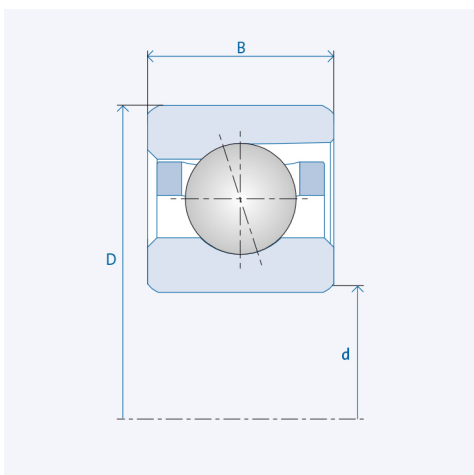

Precision class P4 / ABEC7

Components

| | |
|------------------------------|---------------------------------|
| Bearing designation: | (HY)* S 6002 C |
| Bearing design: | S |
| Series / size: | 6002 |
| Ball material: | Steel 100Cr6 |
| Ball material HY : | Ceramic Si3N4 |
| Cage: | TA (TXM available upon request) |
| Precision: | P4 (HG, UP, P2 upon request) |
| Main dimensions [d x D x B]: | 15 x 32 x 9 mm |

Technical data (Standard bearings)

| | |
|------------------------------|-------|
| Static load capacity C_0 : | 3750 |
| Dynamic load capacity C: | 6650 |
| Speed limit n_{Fett} : | 54000 |
| Speed limit n_{Oj} : | 72000 |

Technical data (Hybrid bearings)*

| | |
|----------------------------------|-------|
| Static load capacity C_{0HY} : | 2650 |
| Dynamic load capacity C_{HY} : | 6650 |
| Speed limit n_{Fett} : | 67500 |
| Speed limit n_{Oj} : | 90000 |

Pre-tension

| | |
|------------------------------|---------------|
| Light (L): | 32 N |
| Axial rigidity (C_{ax}): | 22 N/ μ m |
| Medium (M): | 100 N |
| Axial rigidity (C_{ax}): | 38 N/ μ m |
| Heavy (S): | 200 N |
| Axial rigidity (C_{ax}): | 55 N/ μ m |
| Spring preload (Ff): | 170 N |

The given speed limits apply to individual bearings with spring preload. Correction factors must be considered for all properties which deviate from this.

* All ball bearings are also available as hybrid ball bearings (HY).