

Spindle ball bearings (HY)* S 6201 E

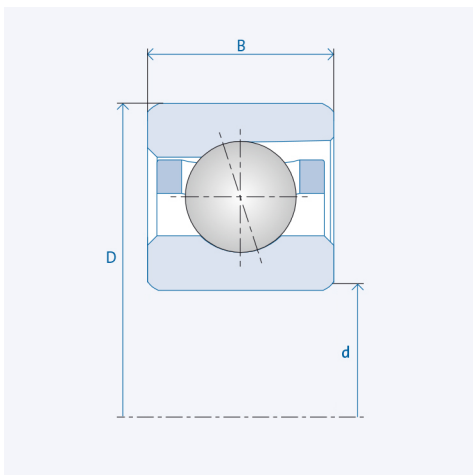

Precision class P4 / ABEC7

Components

Bearing designation:	(HY)* S 6201 E
Bearing design:	S
Series / size:	6201
Ball material:	Steel 100Cr6
Ball material HY :	Ceramic Si3N4
Cage:	TA (TXM available upon request)
Precision:	P4 (HG, UP, P2 upon request)
Main dimensions [d x D x B]:	12 x 32 x 10 mm

Technical data (Standard bearings)

Static load capacity C_0 :	4050
Dynamic load capacity C:	8000
Speed limit n_{Fett} :	49500
Speed limit n_{Oj} :	66000

Technical data (Hybrid bearings)*

Static load capacity C_{0HY} :	2850
Dynamic load capacity C_{HY} :	8000
Speed limit n_{Fett} :	61875
Speed limit n_{Oj} :	82500

Pre-tension

Light (L):	70 N
Axial rigidity (C_{ax}):	56 N/ μ m
Medium (M):	200 N
Axial rigidity (C_{ax}):	84 N/ μ m
Heavy (S):	400 N
Axial rigidity (C_{ax}):	112 N/ μ m
Spring preload (Ff):	290 N

The given speed limits apply to individual bearings with spring preload. Correction factors must be considered for all properties which deviate from this.

* All ball bearings are also available as hybrid ball bearings (HY).