

Spindle ball bearings (HY)* S 61800 C

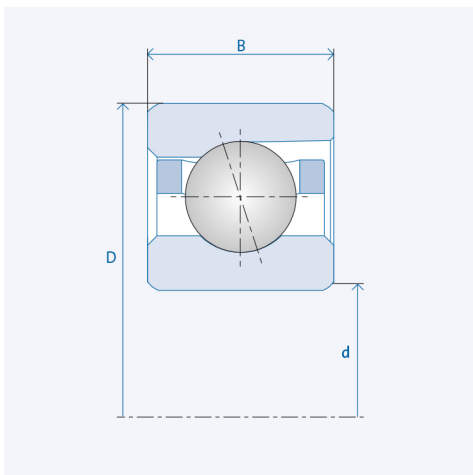
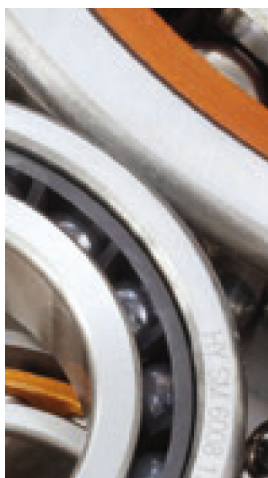

Precision class P4 / ABEC7

Components

Bearing designation:	(HY)* S 61800 C
Bearing design:	S
Series / size:	61800
Ball material:	Steel 100Cr6
Ball material HY :	Ceramic Si3N4
Cage:	TA (TXM available upon request)
Precision:	P4 (HG, UP, P2 upon request)
Main dimensions [d x D x B]:	10 x 19 x 5 mm

Technical data (Standard bearings)

Static load capacity C_0 :	830
Dynamic load capacity C:	1660
Speed limit n_{Fett} :	86250
Speed limit n_{Oj} :	115000

Technical data (Hybrid bearings)*

Static load capacity C_{0HY} :	580
Dynamic load capacity C_{HY} :	1660
Speed limit n_{Fett} :	107812.5
Speed limit n_{Oj} :	143750

Pre-tension

Light (L):	8 N
Axial rigidity (C_{ax}):	10 N/ μ m
Medium (M):	25 N
Axial rigidity (C_{ax}):	17 N/ μ m
Heavy (S):	50 N
Axial rigidity (C_{ax}):	23 N/ μ m
Spring preload (Ff):	45 N

The given speed limits apply to individual bearings with spring preload. Correction factors must be considered for all properties which deviate from this.

* All ball bearings are also available as hybrid ball bearings (HY).