

# Spindle ball bearings (HY)\* S 605 C

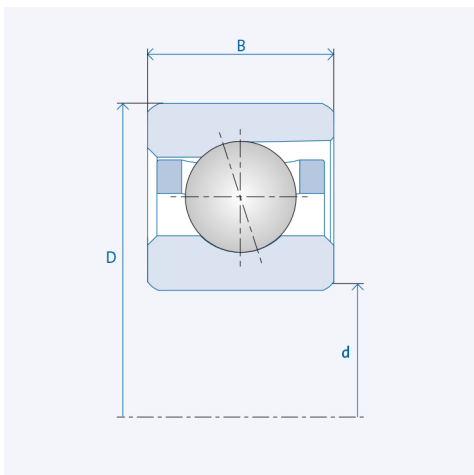

## Precision class P4 / ABEC7

### Components

Bearing designation:	(HY)* S 605 C
Bearing design:	S
Series / size:	605
Ball material:	Steel 100Cr6
Ball material HY :	Ceramic Si3N4
Cage:	TA (TXM available upon request)
Precision:	P4 (HG, UP, P2 upon request)
Main dimensions [d x D x B]:	5 x 14 x 5 mm

### Technical data (Standard bearings)

Static load capacity $C_0$ :	545
Dynamic load capacity C:	1400
Speed limit $n_{Fett}$ :	146250
Speed limit $n_{Oj}$ :	195000

### Technical data (Hybrid bearings)\*

Static load capacity $C_{0HY}$ :	385
Dynamic load capacity $C_{HY}$ :	1400
Speed limit $n_{Fett}$ :	182812.5
Speed limit $n_{Oj}$ :	243750

### Pre-tension

Light (L):	7 N
Axial rigidity ( $C_{ax}$ ):	8 N/ $\mu$ m
Medium (M):	20 N
Axial rigidity ( $C_{ax}$ ):	13 N/ $\mu$ m
Heavy (S):	40 N
Axial rigidity ( $C_{ax}$ ):	20 N/ $\mu$ m
Spring preload (Ff):	40 N

The given speed limits apply to individual bearings with spring preload. Correction factors must be considered for all properties which deviate from this.

\* All ball bearings are also available as hybrid ball bearings (HY).