

# Spindle ball bearings (HY)\* S 6007 E

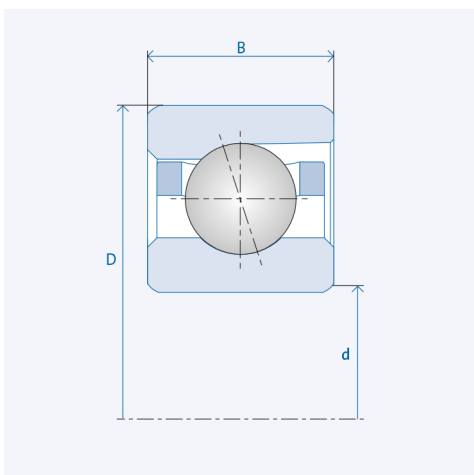

## Precision class P4 / ABEC7

### Components

Bearing designation:	(HY)* S 6007 E
Bearing design:	S
Series / size:	6007
Ball material:	Steel 100Cr6
Ball material HY :	Ceramic Si3N4
Cage:	TA (TXM available upon request)
Precision:	P4 (HG, UP, P2 upon request)
Main dimensions [d x D x B]:	35 x 62 x 14 mm

### Technical data (Standard bearings)

Static load capacity $C_0$ :	14800
Dynamic load capacity C:	19600
Speed limit $n_{Fett}$ :	22500
Speed limit $n_{Oj}$ :	30000

### Technical data (Hybrid bearings)\*

Static load capacity $C_{0HY}$ :	10400
Dynamic load capacity $C_{HY}$ :	19600
Speed limit $n_{Fett}$ :	28125
Speed limit $n_{Oj}$ :	37500

### Pre-tension

Light (L):	170 N
Axial rigidity ( $C_{ax}$ ):	118 N/ $\mu$ m
Medium (M):	500 N
Axial rigidity ( $C_{ax}$ ):	180 N/ $\mu$ m
Heavy (S):	1000 N
Axial rigidity ( $C_{ax}$ ):	245 N/ $\mu$ m
Spring preload (Ff):	715 N

The given speed limits apply to individual bearings with spring preload. Correction factors must be considered for all properties which deviate from this.

\* All ball bearings are also available as hybrid ball bearings (HY).