

# Ball Bearing Freewheel Clutch Unit FK 6205-2RS



Item number 301092

## Components

<b>Freewheel clutch</b>	<b>Insert Element FE 400 Z2</b>
· Rings	Bearing steel, hardened and ground
Inner ring	Press fit
Outer ring	Press fit
· Ball bearings	integrated

## Key values

Ø Shaft d:	25 mm
Ø Hub D:	52 mm
Installed width W:	15 mm
Torque $T_{nom}$ :	104 Nm
Speed $n_{max}$ :	5400 rpm
Weight:	0.15 kg
Load capacity $C_{dyn}$ :	7448 N
Load capacity $C_{stat}$ :	5146 N
Edge radius r:	1,5 mm
Operating temperature:	max. 140°C

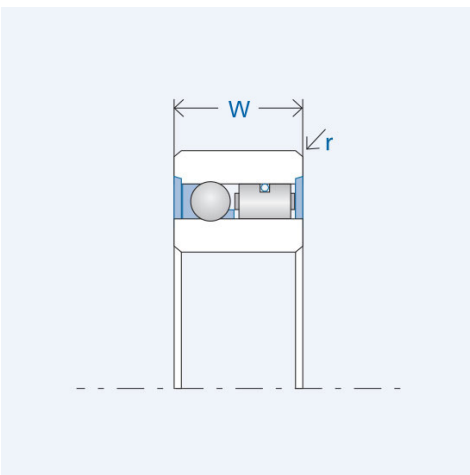
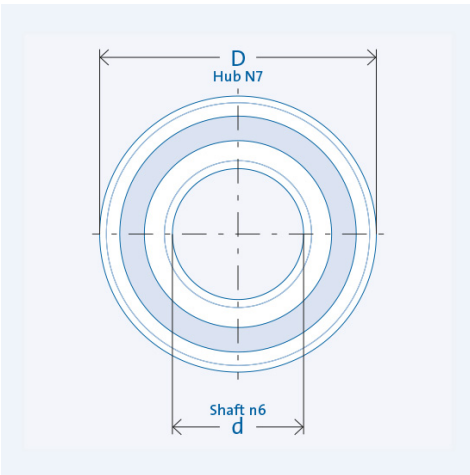

## Lubrication

Oil or grease lubrication

Delivered with corrosion protection.

## Installation

### Installation tolerances

Shaft n6; hub N7

### Mating parts

Hardening and grinding of the mating parts is not necessary. Thoroughly clean (grease free) the mating parts in the vicinity of the freewheel clutch as well as the freewheel clutch's rings before making the press fit.

### Bearing

The freewheel clutch includes ball and roller bearings. Additional external bearing support is not necessary.

### Press fit pressure

Press fit pressure must not be applied to the balls.

### Clamping direction

The arrow on the inner ring designates the inner ring's clamping direction.