

# Complete Freewheel Clutch Unit FN 459 M

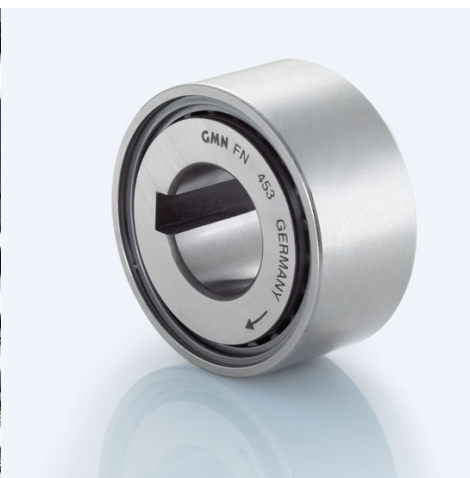

Item number 300726

## Components

<b>Freewheel clutch</b>	<b>Insert Element FE 400 M</b>
· Rings	Bearing steel, hardened and ground
Inner ring	Keyway per DIN 6885, Sheet 1
	Tolerance: P9 with back clearance
Outer ring	Press fit
· Ball bearings	integrated
· Roller bearing	RL 400

## Key values

Ø Shaft d:	30 mm
Ø Hub D:	64 mm
Installed width W:	27 mm
Torque $T_{nom}$ :	411 Nm
Number of sprags:	57
Speed $n_{max}$ :	3000 rpm
Weight:	0.43 kg
Load capacity $C_{dyn}$ :	12691 N
Load capacity $C_{stat}$ :	16320 N
Keyway width b:	8 mm
Keyway depth t:	3,3 mm
Operating temperature:	max. 140°C

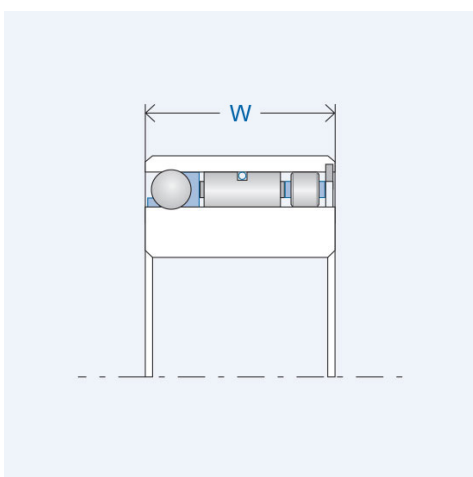
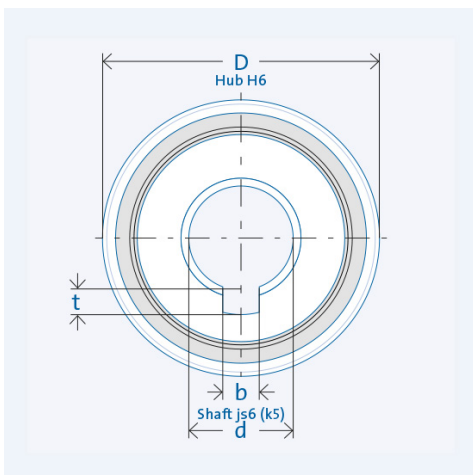

## Lubrication

### Oil or grease lubrication

Delivered with corrosion protection.  
Operative grease filling on request.

## Installation

### Installation tolerances

Shaft js6 (k5); hub H6

### Mating parts

Hardening and grinding of the mating parts is not necessary.  
Thoroughly clean (grease free) the mating parts in the vicinity of the freewheel clutch as well as the freewheel clutch's rings before making the press fit.

### Bearing

The freewheel clutch includes ball and roller bearings.  
Additional external bearing support is not necessary.

### Press fit pressure

Press fit pressure must not be applied to the balls.

### Clamping direction

The arrow on the inner ring designates the inner ring's clamping direction.