

Labyrinth plastic seal Type S

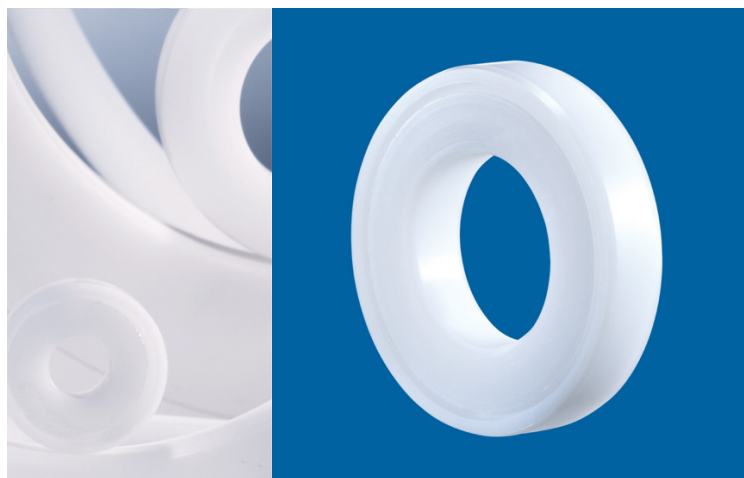

S 40 X 68 X 10

Item number 301570

Technical data

Material:	High-quality polyoxymethylene (POM)
Inner diameter ID:	40 mm
Outer diameter OD:	68 mm
Installed width W:	10 mm
Sealing gap:	Conical
Axial play S_{ax}^* :	0.8 mm
Gap diameter e_1 :	47 mm
Gap diameter e_2 :	61 mm
Speed limit:	21000 rpm
Weight:	0.0263 kg
Operating temperature t:	-40° - 60°C

*Entire movability from one end position to the other

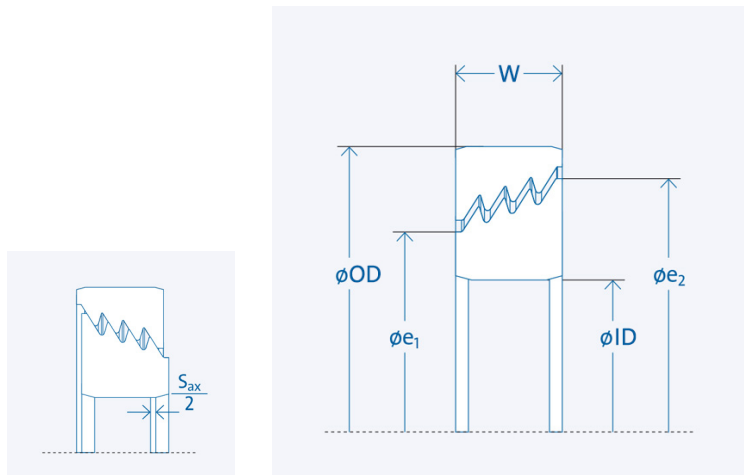

Installation

"l" Length (chamfering of shaft and housing) depending on the width W: $l = 0,1 \times W$

Component tolerances

Surrounding structure (mating parts)

Housing: H7 / Shaft: h7

Surface quality: $Rz \leq 16 \mu m$; $Ra \leq 3,2 \mu m$

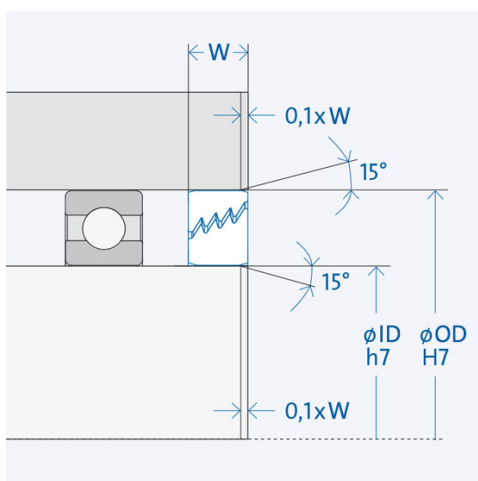

The larger gap diameter e_2 must always face the impact.