

# Labyrinth Metal Seal Type L



L 75 X 90 X 10

Item number 301257

## Technical data

Outer ring material*:	Aluminum (GD AISi 12)
Inner ring material:	Unalloyed construction steel
Inner diameter ID:	75 mm
Outer diameter OD:	90 mm
Installed width W:	10 mm
Sealing gap:	Horizontal
Axial play $S_{ax}$ **:	0.42 mm
Radial play $S_{rad}$ **:	$S_{rad} = S_{ax} / \tan(42,5^\circ)$
Gap diameter e:	86 mm
Gap height:	Constant 0,2– 0,5 mm (depending upon size)
Speed limit:	15000 rpm
Weight:	0.1014 kg
Operating temperature t:	-40° - 200°C

Axial play:

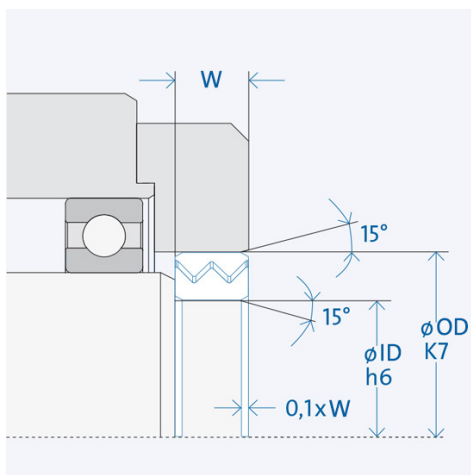
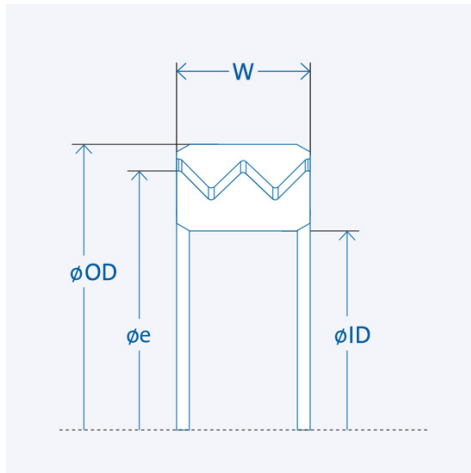
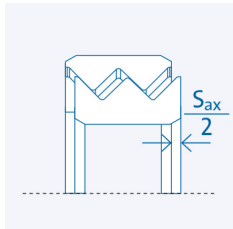

\*Aluminum outer ring  
The aluminum outer ring can be slightly non-round as supplied. By pressing in the seal, the relatively easily deformable ring fits the roundness of the hub.  
The outer ring can be up to 0.1 mm wider than the inner ring due to manufacturing. GMN metal labyrinth seals are pressed through a calibration ring ('zero dimension'). The outer ring then springs back due to its elasticity.

\*\*Entire movability from one end position to the other.

## Installation

"l" Length (chamfering of shaft and housing) depending on the width W:  $l = 0,1 \times B$

## Component tolerances

Surrounding structure (mating parts)

Housing: K7 / Shaft: h6

Surface quality:  $Rz \leq 16 \mu\text{m}$ ;  $Ra \leq 3,2 \mu\text{m}$