

Labyrinth plastic seal Type SA



SA 35 X 72 X 10

Item number 301824

Technical data

| | |
|--------------------------|-------------------------------------|
| Material: | High-quality polyoxymethylene (POM) |
| Inner diameter ID: | 35 mm |
| Outer diameter OD: | 72 mm |
| Installed width W: | 10 mm |
| Sealing gap: | Conical |
| Axial play S_{ax}^* : | 0.8 mm |
| Gap diameter e_1 : | 47 mm |
| Gap diameter e_2 : | 61 mm |
| Speed limit: | 22600 rpm |
| Weight: | 0.0344 kg |
| Operating temperature t: | -40° - 60°C |

*Entire movability from one end position to the other

Heavy and direct splashing liquids could be drained through an additional groove in the outer ring – for rotating shafts only.

Installation

"l" Length (chamfering of shaft and housing) depending on the width W: $l = 0,1 \times B$

Component tolerances

Surrounding structure (mating parts)

Housing: H7 / Shaft: h7

Surface quality: $R_z \leq 16 \mu\text{m}$; $R_a \leq 3,2 \mu\text{m}$

Axial play:

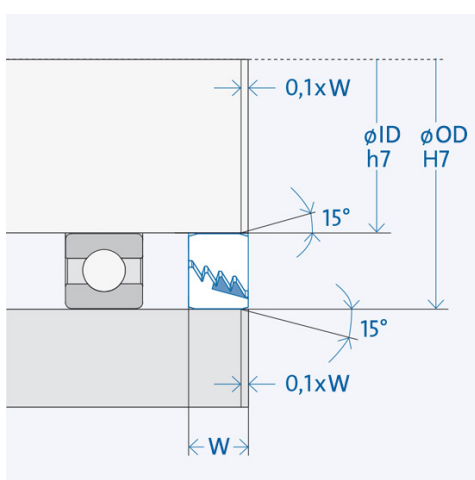
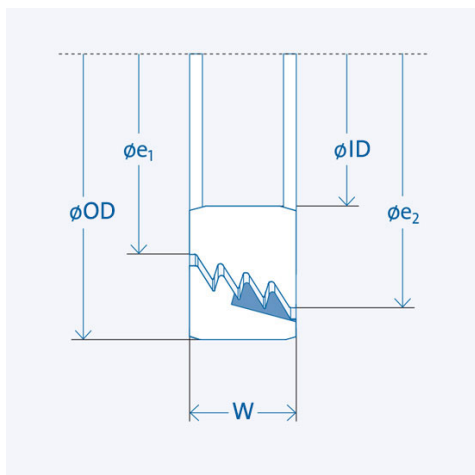
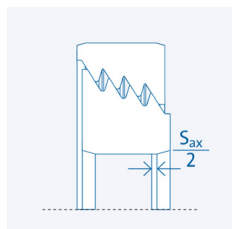

The larger gap diameter e_2 must always face the impact.

The groove in the stationary part must be positioned at the lowest point.