

Labyrinth plastic seal Type SA



SA 20 X 42 X 10

Item number 301779

Technical data

Material:	High-quality polyoxymethylene (POM)
Inner diameter ID:	20 mm
Outer diameter OD:	42 mm
Installed width W:	10 mm
Sealing gap:	Conical
Axial play S_{ax}^* :	0.8 mm
Gap diameter e_1 :	24 mm
Gap diameter e_2 :	34 mm
Speed limit:	51300 rpm
Weight:	0.0119 kg
Operating temperature t:	-40° - 60°C

*Entire movability from one end position to the other

Heavy and direct splashing liquids could be drained through an additional groove in the outer ring – for rotating shafts only.

Installation

"l" Length (chamfering of shaft and housing) depending on the width W: $l = 0,1 \times B$

Component tolerances

Surrounding structure (mating parts)

Housing: H7 / Shaft: h7

Surface quality: $Rz \leq 16 \mu\text{m}$; $Ra \leq 3,2 \mu\text{m}$

Axial play:

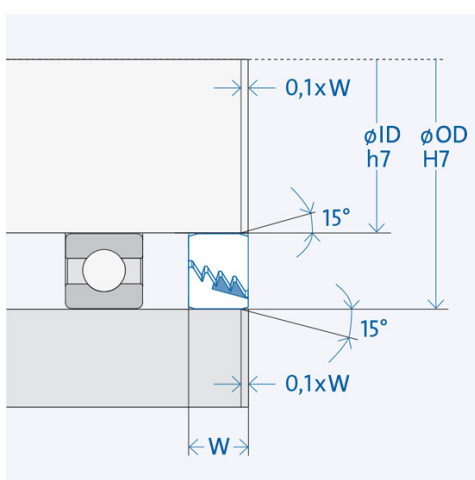
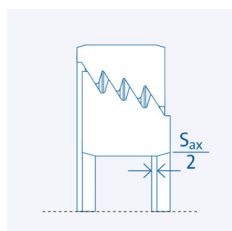

The larger gap diameter e_2 must always face the impact.

The groove in the stationary part must be positioned at the lowest point.