

# Labyrinth plastic seal Type SA



SA 10 X 30 X 10

Item number 301753

## Technical data

Material:	High-quality polyoxymethylene (POM)
Inner diameter ID:	10 mm
Outer diameter OD:	30 mm
Installed width W:	10 mm
Sealing gap:	Conical
Axial play $S_{ax}^*$ :	0.8 mm
Gap diameter $e_1$ :	14 mm
Gap diameter $e_2$ :	24 mm
Speed limit:	82000 rpm
Weight:	0.0089 kg
Operating temperature t:	-40° - 60°C

\*Entire movability from one end position to the other

Heavy and direct splashing liquids could be drained through an additional groove in the outer ring – for rotating shafts only.

## Installation

"l" Length (chamfering of shaft and housing) depending on the width W:  $l = 0,1 \times B$

## Component tolerances

Surrounding structure (mating parts)

Housing: H7 / Shaft: h7

Surface quality:  $R_z \leq 16 \mu\text{m}$ ;  $R_a \leq 3,2 \mu\text{m}$

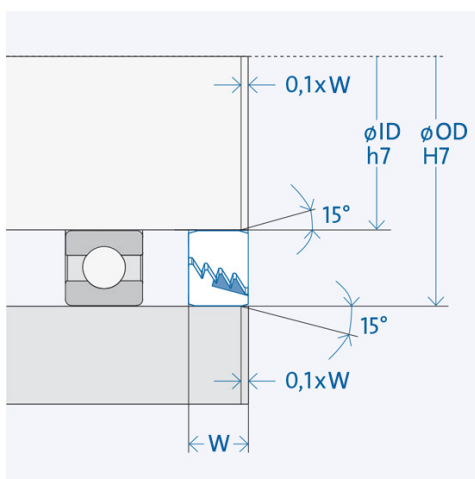
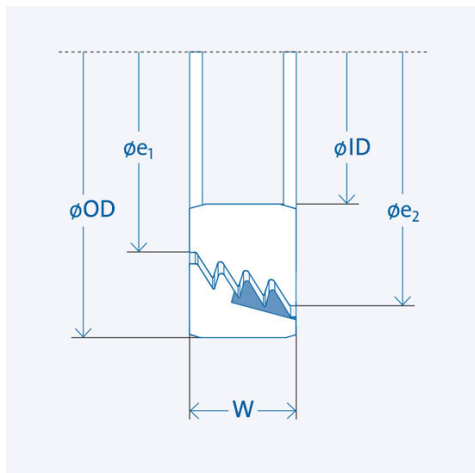

The larger gap diameter  $e_2$  must always face the impact.

The groove in the stationary part must be positioned at the lowest point.

Axial play:

